

**DUARTECRUZ**

— SINCE 1956 —

**Caderno Geral**

Ao longo de seis décadas de atividade, a firma **DUARTECRUZ** Fabrica de Plásticos, Lda., fundada em 1956, dedica-se ao fabrico de todo o tipo de perfis plásticos a partir de PVC, PP, ABS e outros.

Produz uma grande variedade de perfis plásticos, com as mais diversas características, destinados a atividade Industrial e Comercial em geral.

A qualidade dos produtos que a empresa fabrica, a versatilidade destes, o esforço e o conhecimento técnico da empresa estão na base do sucesso alcançado.

Ao mesmo tempo a manutenção de uma relação muito especial com os diversos clientes faz com que a **DUARTECRUZ**, seja vista como uma empresa capaz de produzir tudo para os mais diversos fins.

Uma larga experiência e uma particular atenção na diversidade de fabrico permitiu à empresa angariar conhecimentos, os quais aliados à tecnologia empregue no fabrico são suficientes para satisfazer as diversas solicitações.

O departamento técnico da empresa tem capacidade de desenvolver novos perfis e de aconselhar/ colaborar com os seus clientes, propondo soluções em projetos novos apresentados por estes.

# Palete de cores DUARTECRUZ

 03 - Transparente cristal	 64 - Azul turquesa
 04 - Transparente base verde	 65 - Azul
 10 - Opalino	 68 - Azul acinzentado
 15 - Branco	 69 - Cinzento ferro
 16 - Branco frio	 72 - Verde claro
 17 - Natural	 75 - Verde turquesa
 22 - Marfim claro	 76 - Verde escuro
 25 - Marfim	 78 - Verde amarelo
 35 - Amarelo	 79 - Verde alface
 39 - Dourado	 80 - Cinzento escuro
 43 - Castanho ocre (camel)	 83 - Cinzento claro
 44 - Castanho alaranjado	 85 - Cinzento janela
 45 - Castanho	 86 - Mouse grey
 47 - Castanho sépia	 89 - Cinzento prateado
 52 - Cor de rosa claro	 90 - Cinzento metalizado
 53 - Cor de rosa	 95 - Preto
 55 - Vermelho	
 58 - Bordeaux	
 63 - Azul pastel	

# DUARTECRUZ

## Dureza materiais PVC

Rígido .....20 – ShoreD 79

Rígido.....30 – ShoreD 79

Rígido.....39 – ShoreD 78

Semi-rígido.....40 – shoreA 94

Semi-rígido.....50 – shoreA 98

Semi-rígido +.....54 – shoreA 98

Semi-rígido++.....60 – shoreA 97

















Semi-rígido +++.....63 – shoreA 97

Flexível +.....70 – shoreA 85









Flexível ++.....80 – shoreA 74

Flexível+++.....82 – shoreA 74

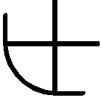
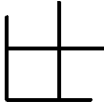
## Índice caderno geral

		pág
Bucha taco		1
Perfis U grandes		2
Perfis U		3
Perfis cantoneira L		4
Perfis cantoneira		5
Perfis calha dupla		6
Perfis H		7
Perfis mola		8
Perfis mola meia-cana		9
Perfis de remate		10
Perfis varão		11
Perfil Tubo		12
Perfis Tubo	 	13
Perfis tipo U		14
Perfil B18		15

## Índice caderno geral

		pág
Perfil D08		16
Perfil 181		17
Perfil A10		18
Perfil C11		19
Perfil A32		20
Perfil A35		21
Perfil 744		22
Perfil 630		23
Perfis de remate		24
Perfis de remate		25

# Bucha Taco

Aplicação Bucha em PVC para fixação

1

**Descritivo** A Bucha Taco (PVC) foi criada e desenvolvida pelo Arquitecto Duarte Cruz fundador da firma DUARTECRUZ-FABRICA DE PLASTICOS LDA (firma fundada em 1956). A DUARTECRUZ desenvolveu um composto de PVC que dadas as suas características permite um desempenho de excelência para o fim a que se destina e permite a adaptabilidade da Bucha a qualquer tipo de estrutura.

AS BUCHAS QUE OS PROFISSIONAIS PREFEREM PELA RAPIDEZ DE UTILIZAÇÃO E

EFICÁCIA DEPOIS DE APLICADAS NOS MAIS DIVERSOS SUPORTES.

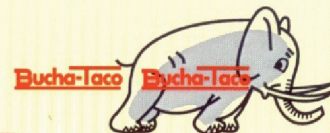

25 mm	38 mm	50 mm	∅	mm	
				6	5
Ref 901	Ref 902				
				8	7
Ref 903	Ref 904				
				10	9
	Ref 906	Ref 907			
				12	11
		Ref 909			



Cores ● 95  
Outras cores sob consulta



Fabrica de Plasticos, Lda Rua Visconde das devesas,305 4401-901 V.N.Gaia

## Perfis U grandes

Descrição Perfil rígido em PVC  
Dureza: shD79

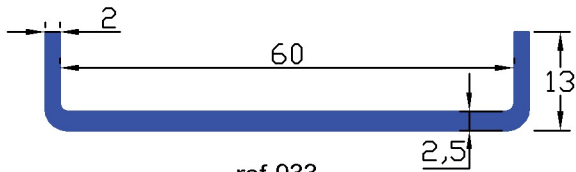

ref 933

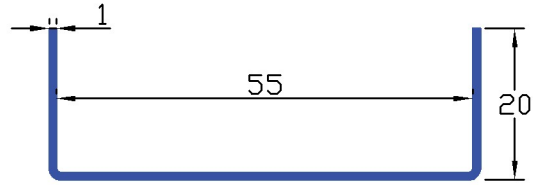

ref 183

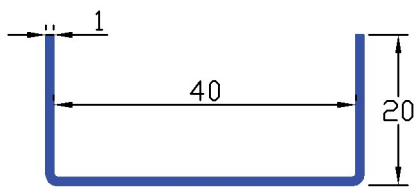

ref 190

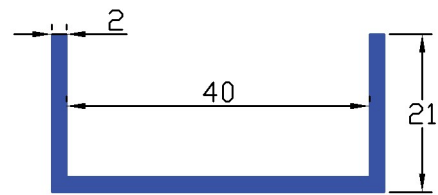

ref 873

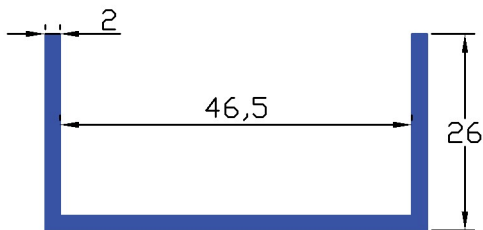

ref 778

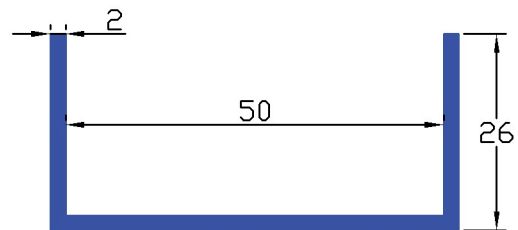

ref 781

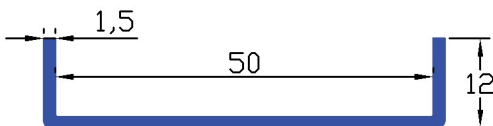

ref 0.63

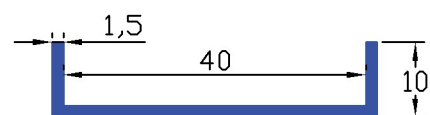

ref 031

**Descritivo** Perfil calha U para múltiplas aplicações.  
Existem perfis PVC com diferentes características dependendo da aplicação a que se destina (ex: dureza, resistência ao choque e à temperatura, tratamento UV, etc).  
Estes perfis podem ainda ser fabricados noutros materiais, nomeadamente ABS, PP, etc  
Podem ainda ser fornecidos com outras medidas, sob consulta.

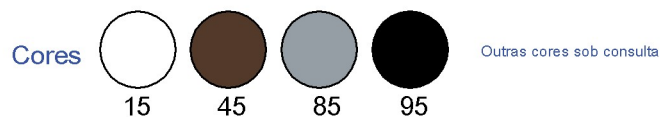

# Perfil U

**Descrição** Perfil rígido em PVC  
**Dureza:** shD79

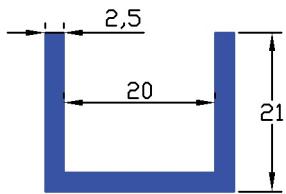

ref 550

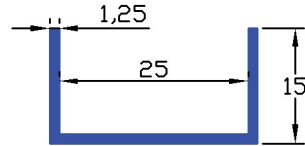

ref B07

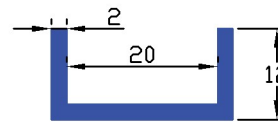

ref 810

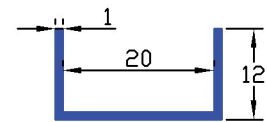

ref 686

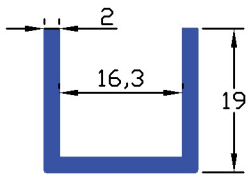

ref 497

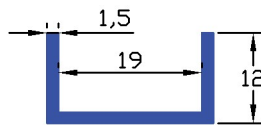

ref 762

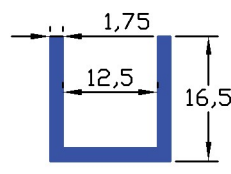

ref 593

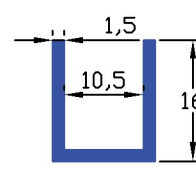

ref 857

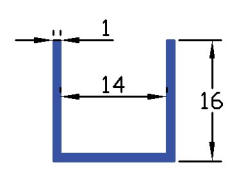

ref 839

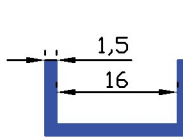

ref 417

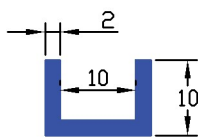

ref 966

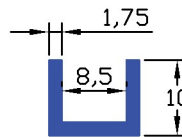

ref 683

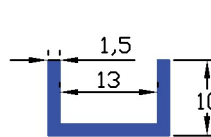

ref 959

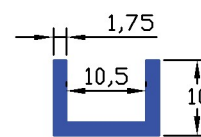

ref 137

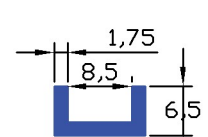

ref 069

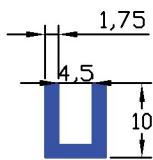

ref 101

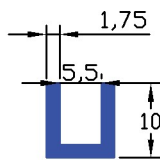

ref 102

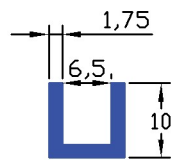

ref 103

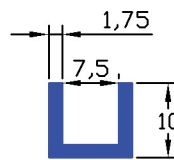

ref 104

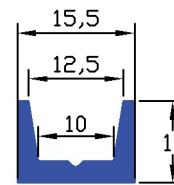

ref 070

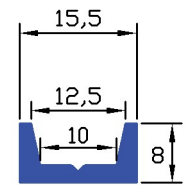

ref 171

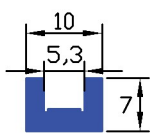

ref 107

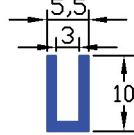

ref A40

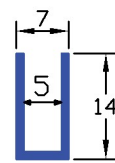

ref 511

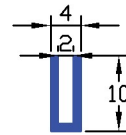

ref A39

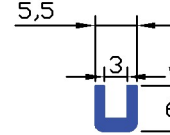

ref C37

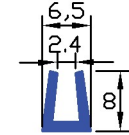

ref 098

**Descritivo** Perfil cantoneira para múltiplas aplicações.

Existem perfis PVC com diferentes características dependendo da aplicação a que se destina (ex: dureza, resistência ao choque e à temperatura, tratamento UV, etc).

Estes perfis podem ainda ser fabricados noutros materiais, nomeadamente ABS, PP, etc  
 Podem ainda ser fornecidos com outras medidas, sob consulta.



**DUARTECRUZ**  
 SINCE 1956

Cores



15



45



85



95

Outras cores sob consulta

Fabrica de Plásticos, Lda Rua Visconde das devesas,305 4401-901 V.N.Gaia

# Perfil cantoneira L

Descrição Perfil rígido em PVC  
Dureza: shD79

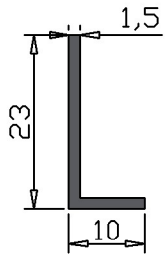

ref 825

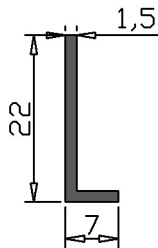

ref 446

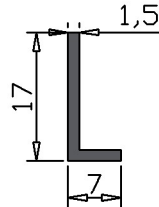

ref 752

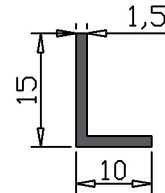

ref 958

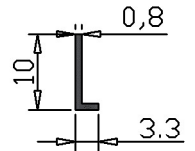

ref B45

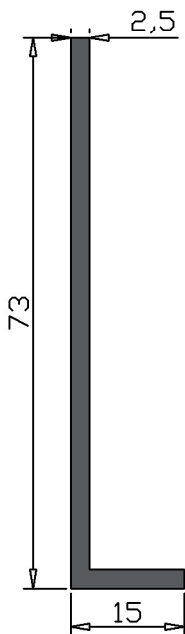

ref 847

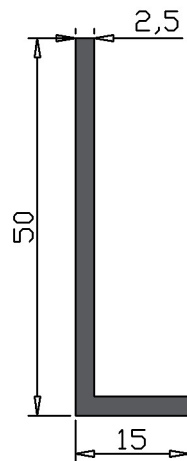

ref 936

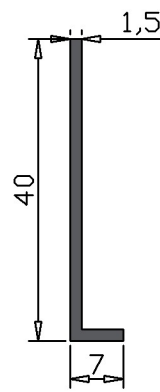

ref C29

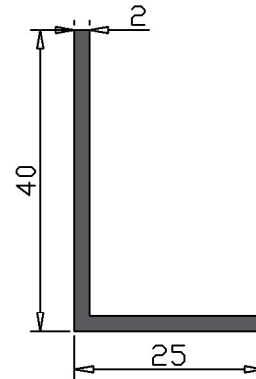

ref 729

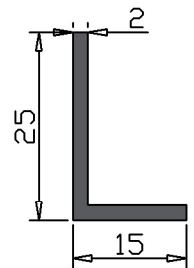

ref 191

**Descritivo** Perfil cantoneira de abas desiguais para multiplas aplicações.  
Existem perfis PVC com diferentes características dependendo da aplicação a que se destina (ex: dureza, resistencia ao choque e à temperatura, tratamento UV, etc).  
Estes perfis podem ainda ser fabricados noutros materiais, nomeadamente ABS, PP, etc  
Podem ainda ser fornecidos com outras medidas, sob consulta.

Cores

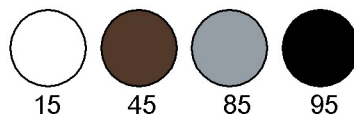

Outras cores sob consulta

# Perfil cantoneira

Descrição Perfil rígido em PVC  
Dureza: shD79

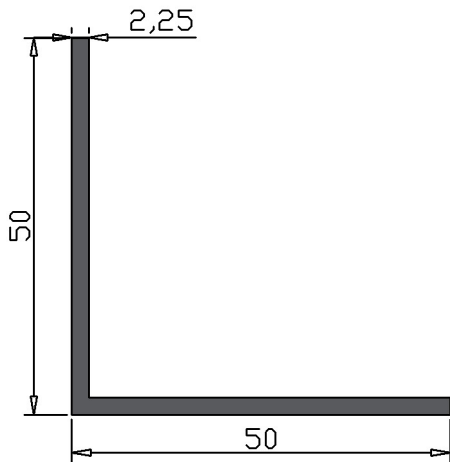

ref 444

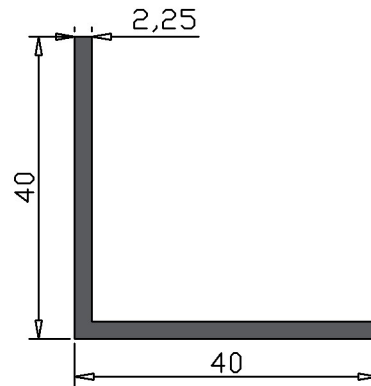

ref 993

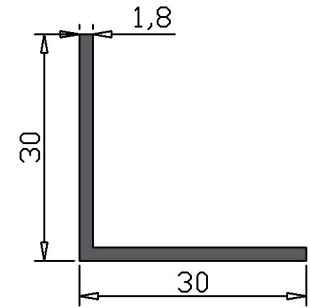

ref 987

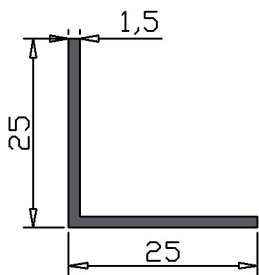

ref 428

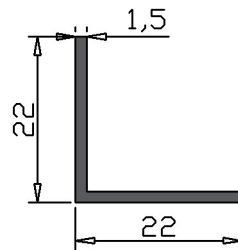

ref 076

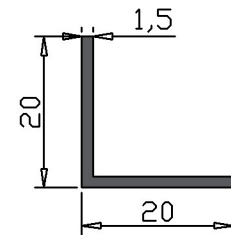

ref 709

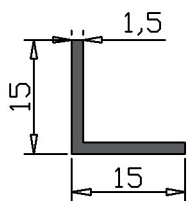

ref 152

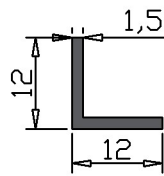

ref 499

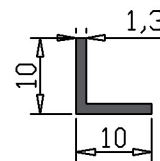

ref 073

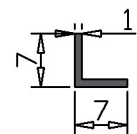

ref 500

**Descritivo** Perfil cantoneira para multiplas aplicações.  
Existem perfis PVC com diferentes características dependendo da aplicação a que se destina (ex: dureza, resistencia ao choque e à temperatura, tratamento UV, etc).  
Estes perfis podem ainda ser fabricados noutros materiais, nomeadamente ABS, PP, etc  
Podem ainda ser fornecidos com outras medidas, sob consulta.

Cores

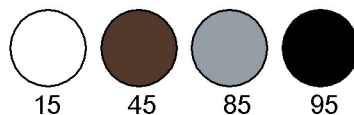

Outras cores sob consulta

# Perfil calha dupla

Descrição Perfil rígido em PVC  
Dureza: shD79

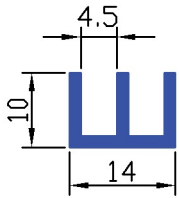

ref 113

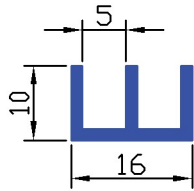

ref 114

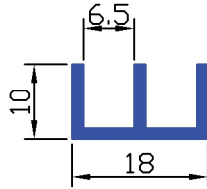

ref 115

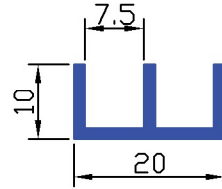

ref 116

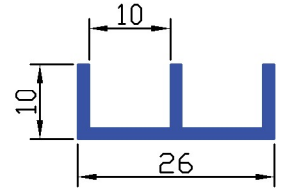

ref 117

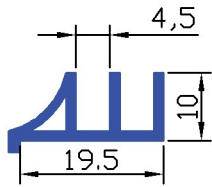

ref 122

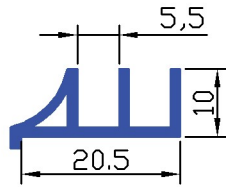

ref 123

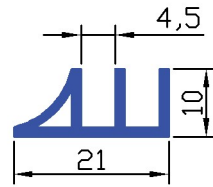

ref 124

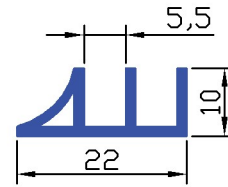

ref 125

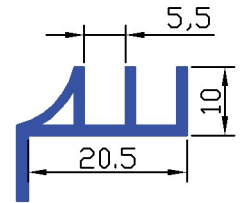

ref 180

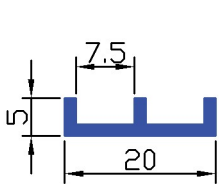

ref 119

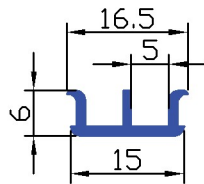

ref 120

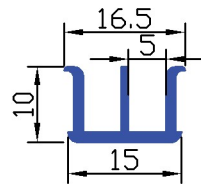

ref 118

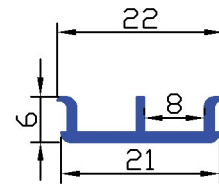

ref 121

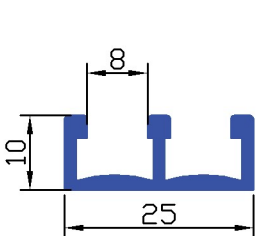

ref A22

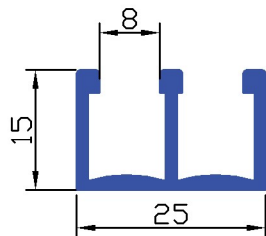

ref A23

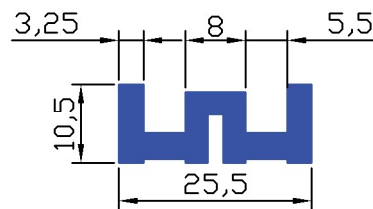

ref 559

Aplicação Perfil calhas duplas de correr

Cores



15



85



45



95

Outras cores sob consulta



**DUARTECRUZ**  
SINCE 1956

Fabrica de Plasticos, Lda Rua Visconde das devesas,305 4401-901 V.N.Gaia

# Perfil H

Descrição Perfil rígido em PVC  
Dureza: shD79

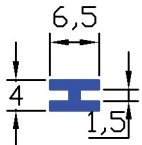

ref 142

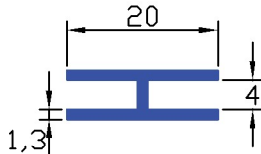

ref 416

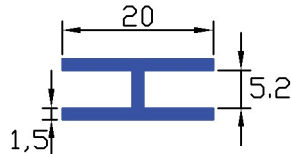

ref 148

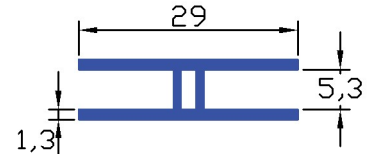

ref 579

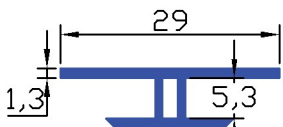

ref 841

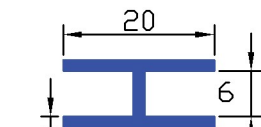

ref 149

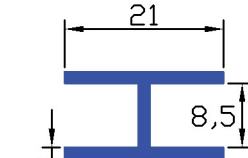

ref 150

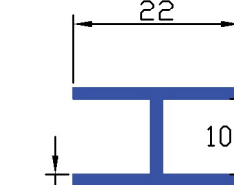

ref 151

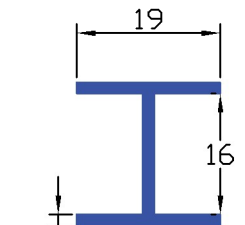

ref 788

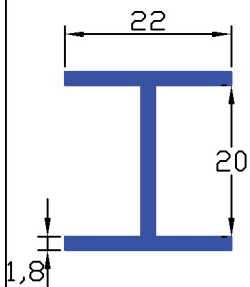

ref 756

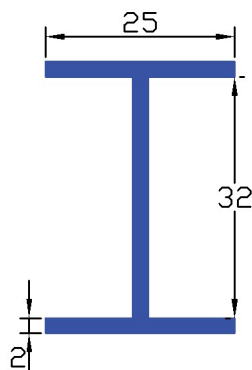

ref 870

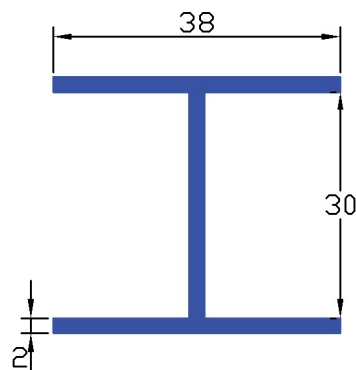

ref 421

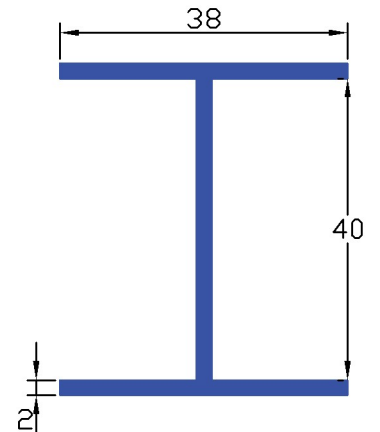

ref 556

Aplicação Perfis de multiplas aplicações sendo a mais comum a união de paineis

Cores



15



85



45



95

Outras cores sob consulta

# Perfil mola

Descrição Perfil rígido em PVC  
Dureza: shD79

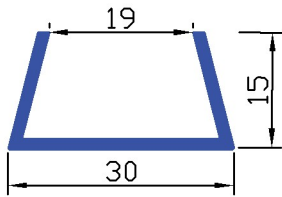

ref 641

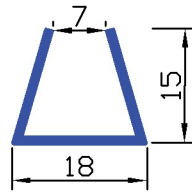

ref 667

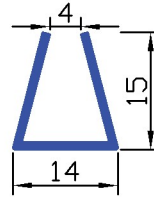

ref 610

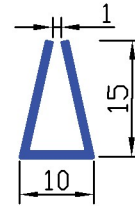

ref 609

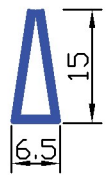

ref 631

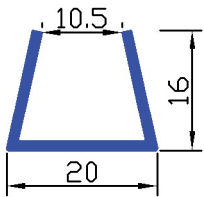

ref 747

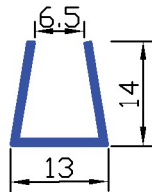

ref 156

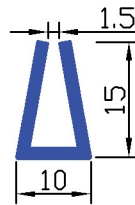

ref 157

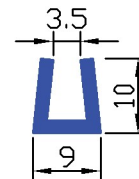

ref 701

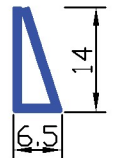

ref 718

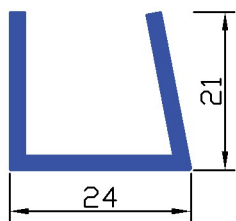

ref 531

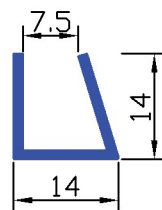

ref 732

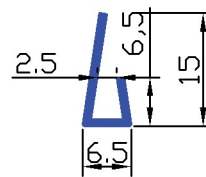

ref 944

Aplicação Perfil com efeito mola para as mais variadas aplicações, entre as quais lombadas para encadernação A4

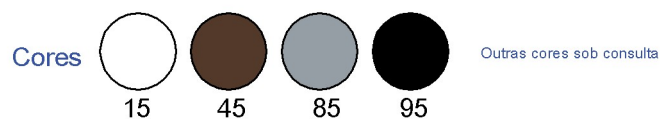

# Perfil mola meia-cana

Descrição Perfil rígido em PVC  
Dureza: shD79

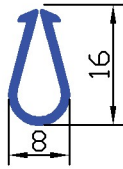

ref 155

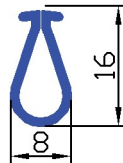

ref 075

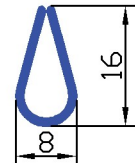

ref 154

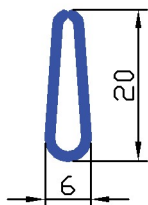

ref A47

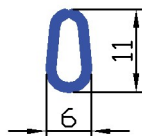



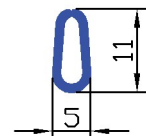

ref 153

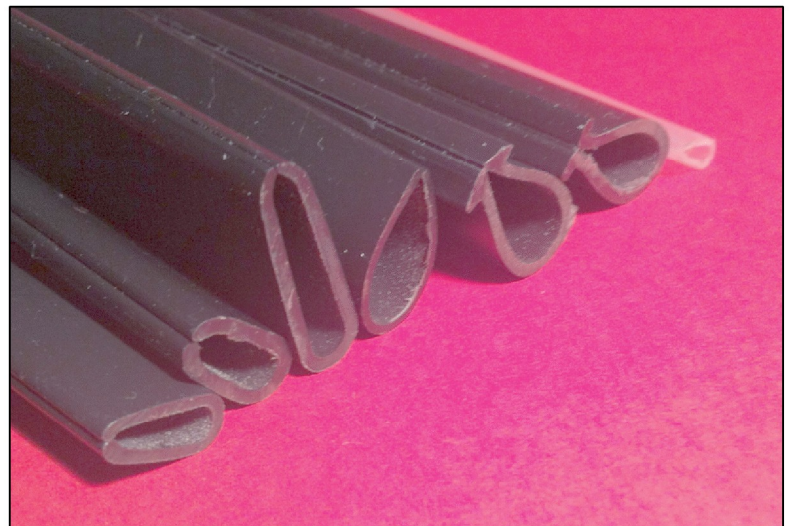
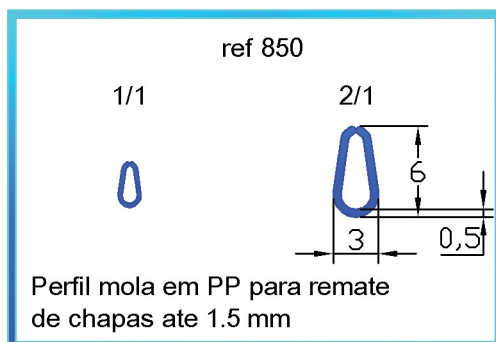

ref 047



Aplicação Perfil com efeito mola para as mais variadas aplicações, entre as quais cartaz de publicidade

Cores     Outras cores sob consulta

15      45      85      95

## Perfil de remate

**Descrição** Perfil semi-rígido em PVC  
**Dureza:** shA94

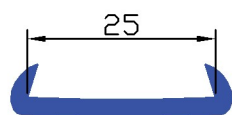

ref C35

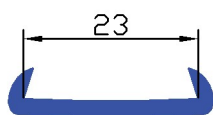

ref B03

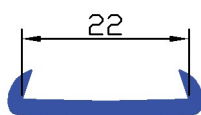

ref B11

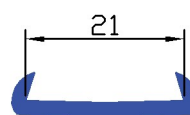

ref C34

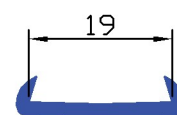

ref B10

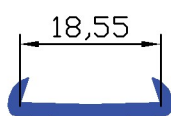

ref C21

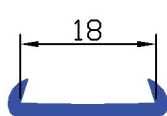

ref C20

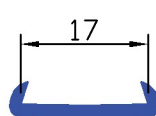

ref B02

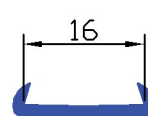

ref B06

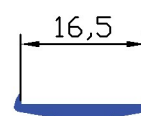

ref D07

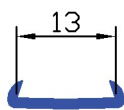

ref B01

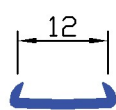

ref C13

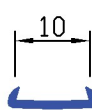

ref C03

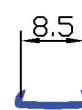

ref B09

### Aplicação Perfil de remate

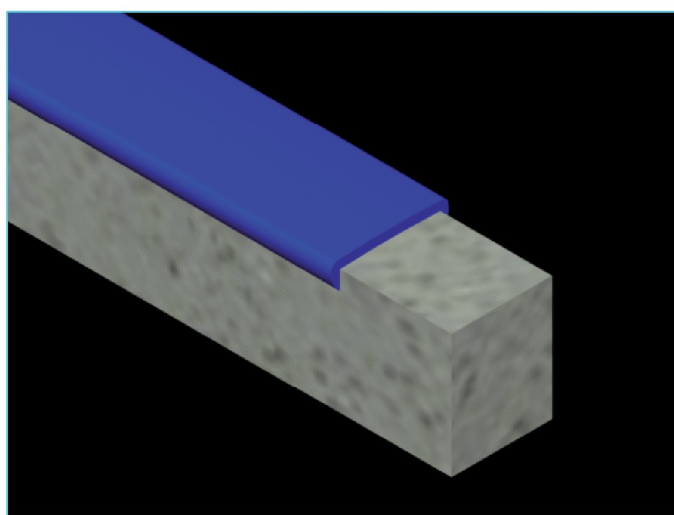

**Descritivo** Perfil para rematar tampos e painéis, nos mais diferentes materiais.  
 Este perfil é de fácil e rápida colocação que confere um remate eficaz  
 Também podemos fornecer estes perfis com fita adesiva dupla face

Cores sob consulta

# Perfil varão

**Descrição** Perfil rígido, semi-rígido ou flexível em PVC, PP, ABS e PEHD  
Outros elastómeros sob consulta

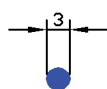

ref 032

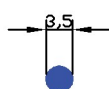

ref 088

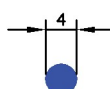

ref083

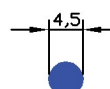

ref 030

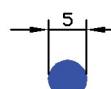

ref 598

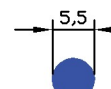

ref 951

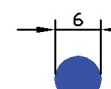

ref 390

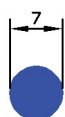

ref 767

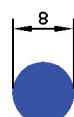

ref 938

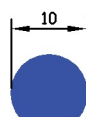

ref657

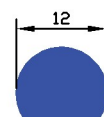

ref 439

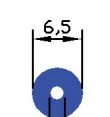

ref 584

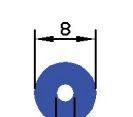

ref 649

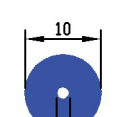

ref 950

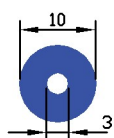

ref 508



ref 815



ref 676



ref 691



ref 891

**Aplicação** Para os mais variados fins

Cores



15



85



44



95

Outras cores sob consulta

# Perfil Tubo

Descrição Perfil rígido e semi-rígido em PVC  
Dureza: shD79

6.5x5x0.75



ref A55

8x6x1



ref 779

9x6x1.5



ref F03

9.5x7.5x1



ref 793

10x5x2.5



ref 616

10x6x2



ref 574

10x8x1



ref 664

12x11x1



ref 765

15x9x3



ref 783

15x8x3.5



ref 698

15x6x4



ref 435

15.5x6x4.75



ref 815

16x12x2



ref 875

16x10x3



ref 782

18x17x0.5

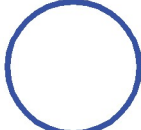

ref 652

20x16x2



ref A09

24x23x0.5

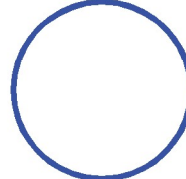

ref C53

29x26x1.5

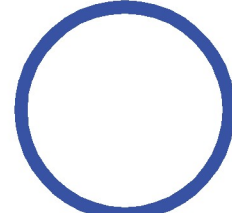

ref 717

29x28x0.5

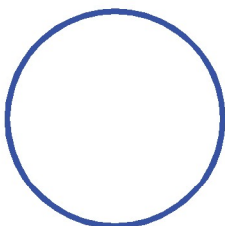

ref 821

31x30x0.5

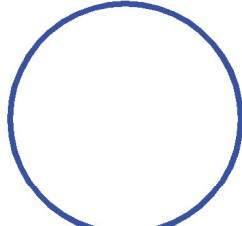

ref 653

46x44x1

ref 899

Cores



15



85



45



95

Outras cores sob consulta



**DUARTECRUZ**  
SINCE 1956

Fabrica de Plasticos, Lda Rua Visconde das devesas,305 4401-901 V.N.Gaia

# Perfil Tubo

Descrição Perfil rígido em PVC  
Dureza: shD79

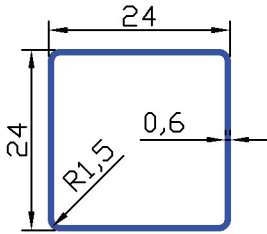

ref 606

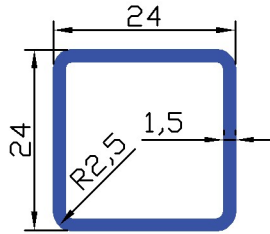

ref 607

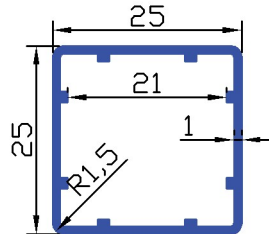

ref 079

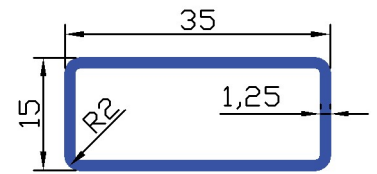

ref 602

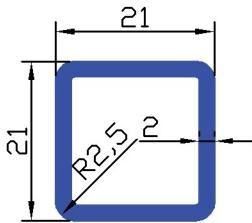

ref 648

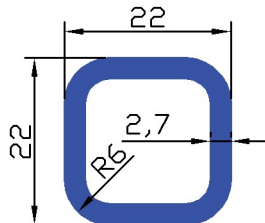

ref 027

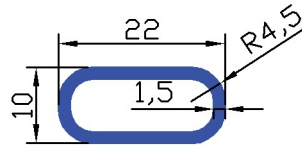

ref 507

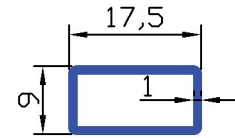

ref 723

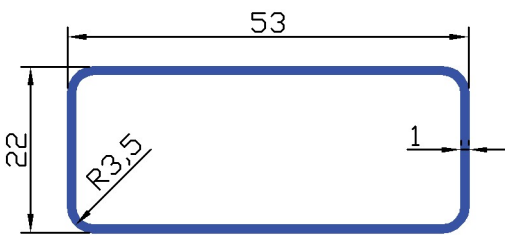

ref 700

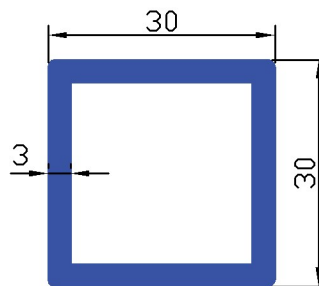



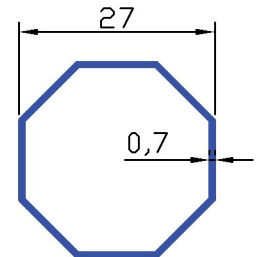

ref D06

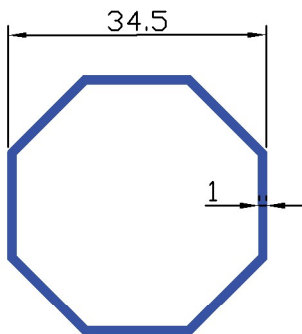

ref 635



ref 625

Cores     Outras cores sob consulta

15 85 45 95

# Perfil tipo U

Descrição Perfil rígido em PVC

Dureza: shD79

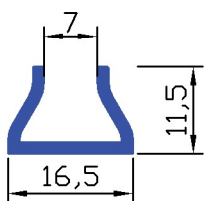

ref 651

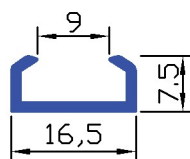

ref 786

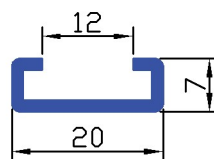

ref 198

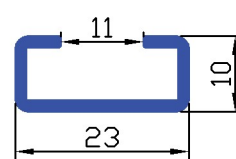

ref 457

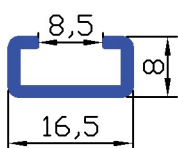

ref 174

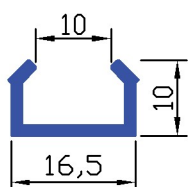

ref 706

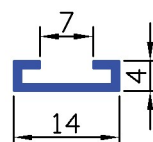

ref 865

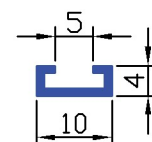

ref 185

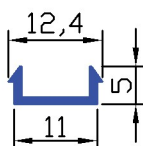

ref 464

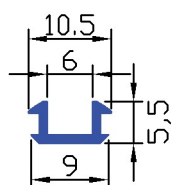

ref 112

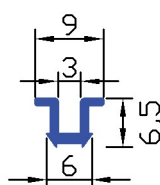

ref 792

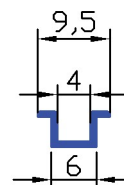

ref 816

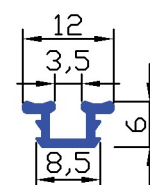

ref 571

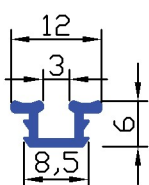

ref 746

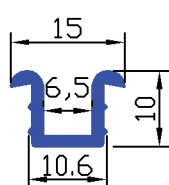

ref 880

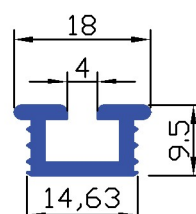

ref 146

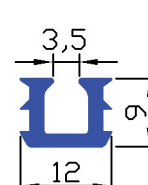

ref 677

Cores



15



85



45



95

Outras cores sob consulta

Perfil ref. **30.B18.00**

Descrição Perfil rígido em PVC

Dureza: shD79



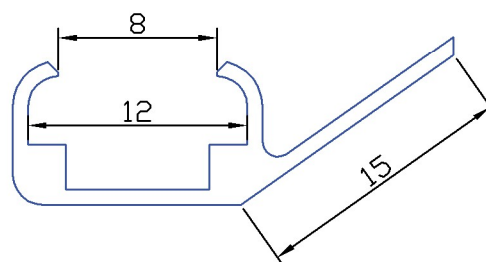

2/1



Aplicação Perfil para suporte fita de leds



Cores    Outras cores sob consulta

15 85 95

Perfil ref. **30.D08.00**

Descrição Perfil rígido em PVC

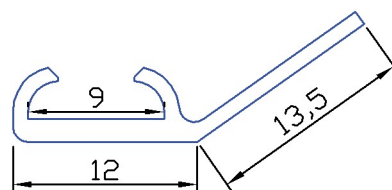

Dureza: shD79

2/1



Aplicação Perfil para suporte fita de leds



Cores    Outras cores sob consulta

15 85 95

Perfil ref. **30.181.00**

Descrição Perfil rígido em PVC

Dureza: shD79

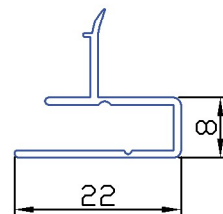
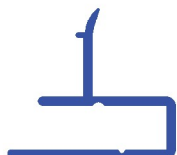

Aplicação Perfil para fixação de cartaz

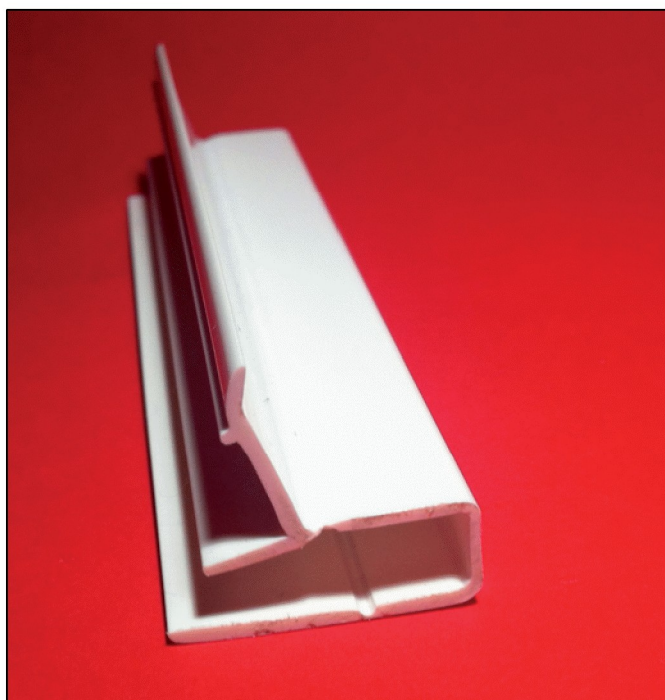

Cores sob consulta

Perfil ref. **30.A10.00**

Descrição Perfil rígido em PVC

Dureza: shD79

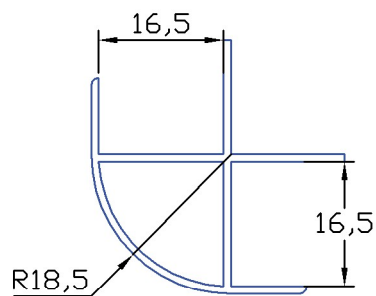
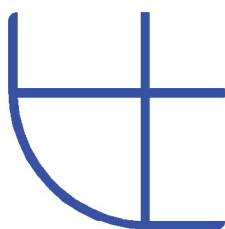

Aplicação Perfil para remate de canto 90°



Cores sob consulta

Perfil ref. **30.C11.00**

Descrição Perfil rígido em PVC

Dureza: shD79

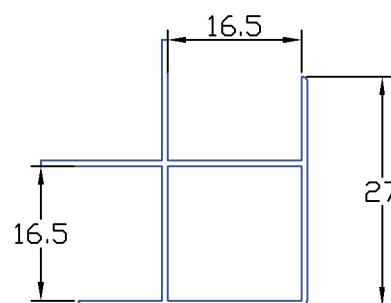
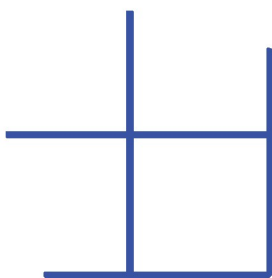

Aplicação Perfil para remate de canto 90°



Cores sob consulta

Perfil ref. **30.A32.00**



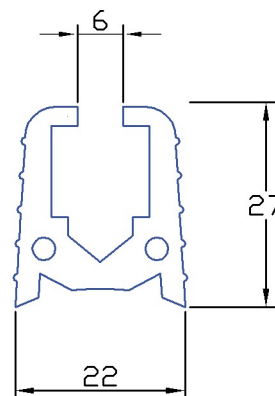
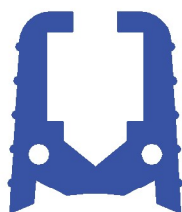

Descrição Perfil rígido em PVC

Dureza: shD79

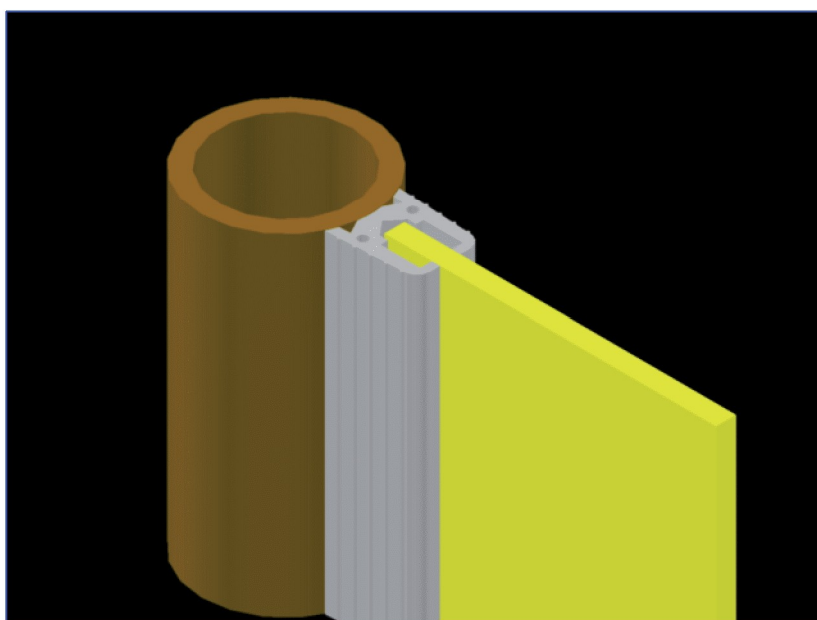

Aplicação Perfil para fixação de acrílico



Cores     Outras cores sob consulta

03 15 85 95

Perfil ref. **40.A35.00**

Descrição Perfil semi-rígido em PVC  
Dureza: shA94

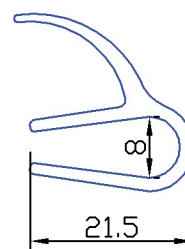
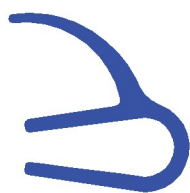

Aplicação Perfil para goteira

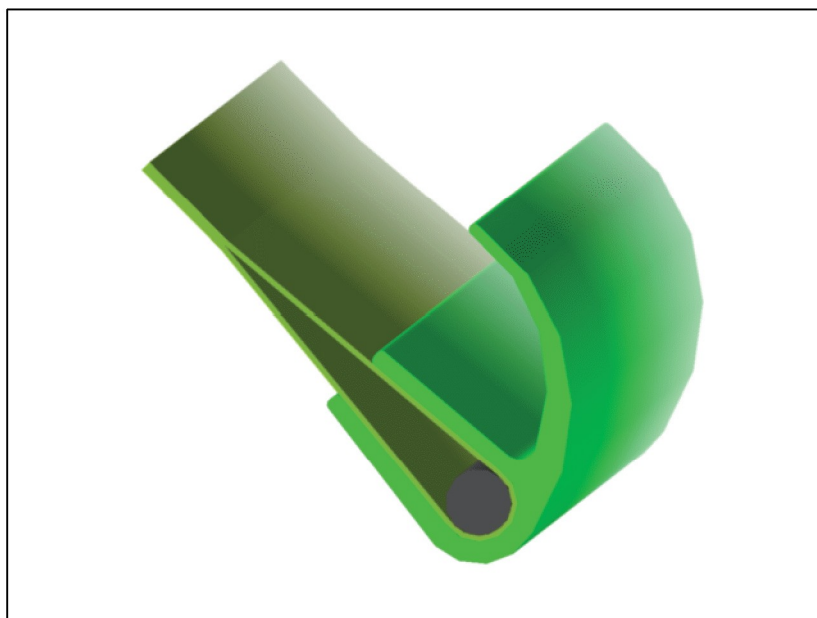

Cores sob consulta

# Perfil rodapé ref. 20.744.85

**Descrição** Perfil rígido em PVC

**Dureza:** shD79

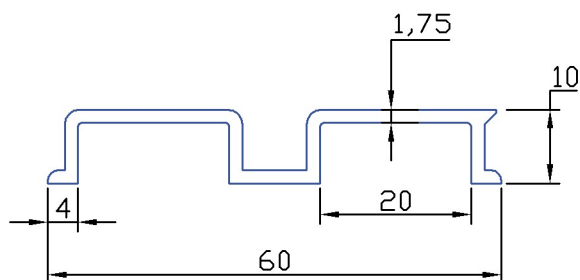

**Aplicação** Perfil para aplicação em rodapés

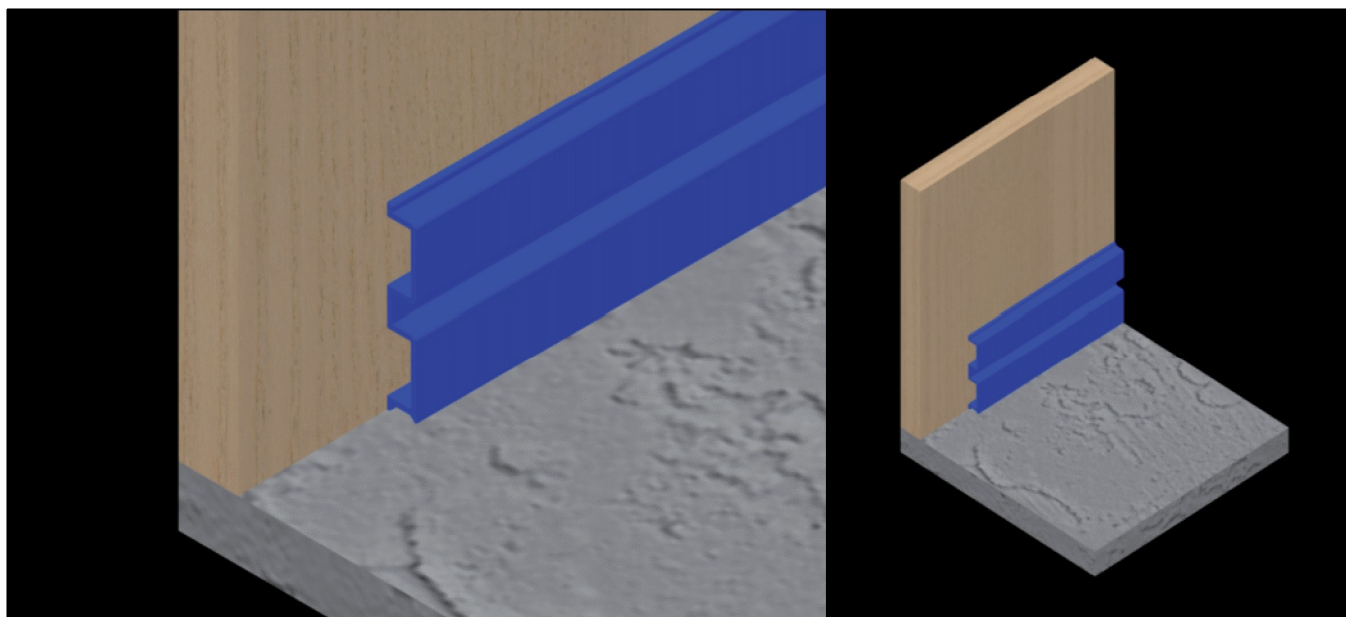

**Descritivo** Este perfil ,pela sua forma, permite a passagem entre a parede e o perfil de todo o tipo de cabos.  
É um perfil com óptima resistência ao choque e a detergentes e solventes, permitindo ainda um bom remate.

Cores



15



45



85



95

Outras cores sob consulta



**DUARTECRUZ**  
SINCE 1956

Fabrica de Plasticos, Lda Rua Visconde das devesas,305 4401-901 V.N.Gaia

## Perfil ref. 30.630.00

Descrição Perfil rígido em PVC

Dureza: shD79

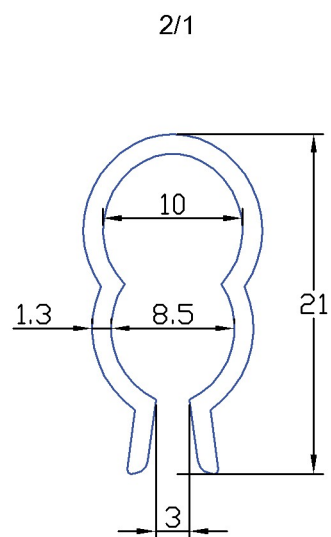

Aplicação Perfil para fixar publicidade em carrinhos de supermercados

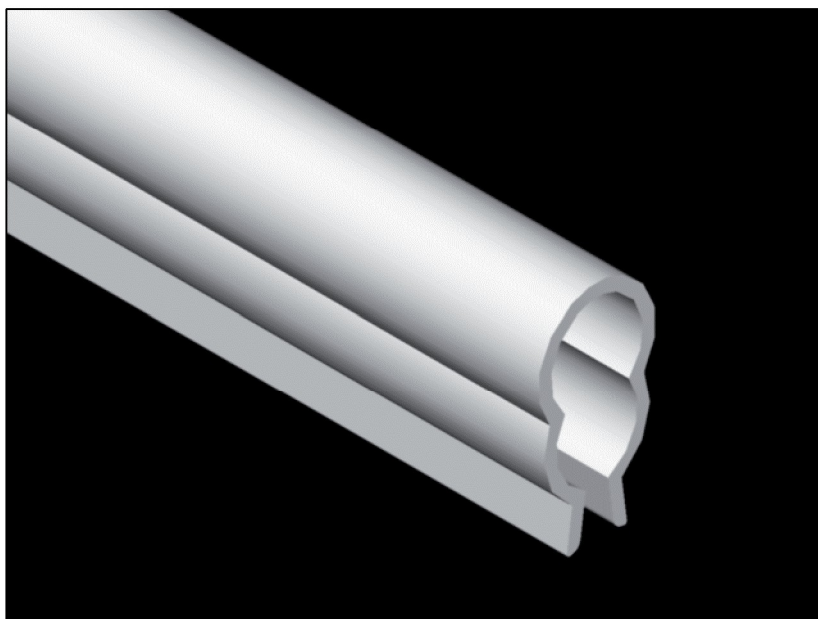

Cores sob consulta

## Perfil de remate

Descrição Perfil semi-rígido em PVC  
Dureza: shA94

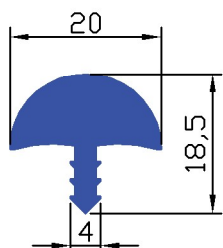

ref 937

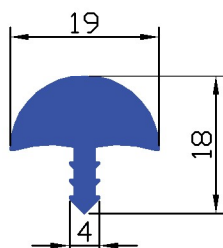

ref 726

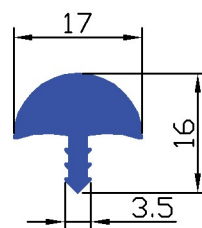

ref 929

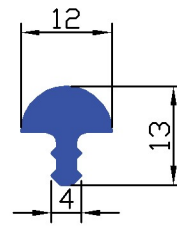

ref 011

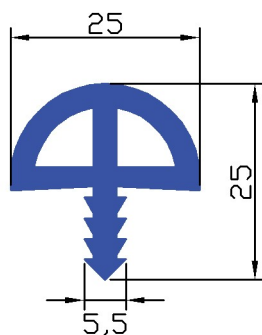

ref 665

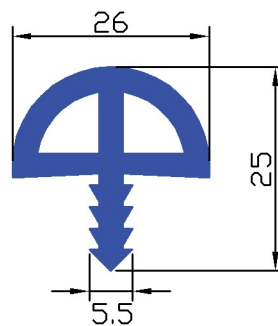

ref 702



Cores



15



85



45



95

Outras cores sob consulta

# Perfil de remate

**Descrição** Perfil semi-rígido em PVC  
**Dureza:** shA94

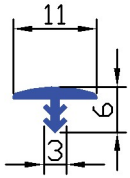

ref 201

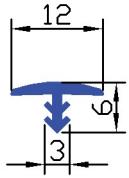

ref 202

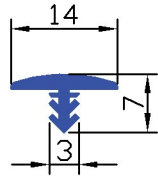

ref 203

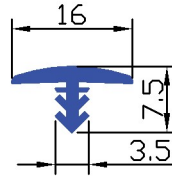

ref 204

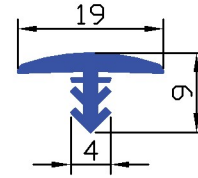

ref 205

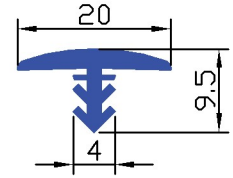

ref 206

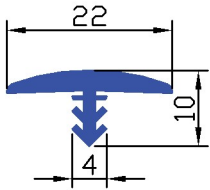

ref 207

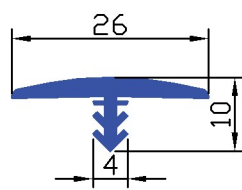

ref 241

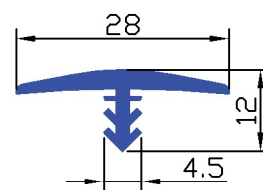

ref 242

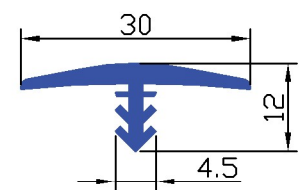

ref 243

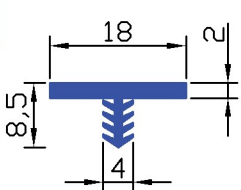

ref 209

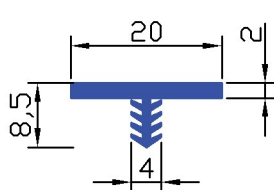

ref 210

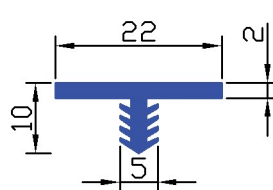

ref 211

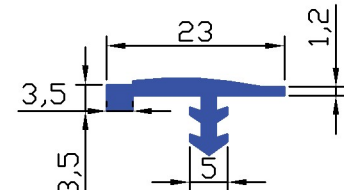

ref 434

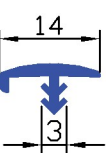

ref 216

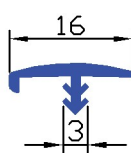

ref 217

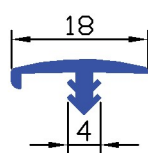

ref 218

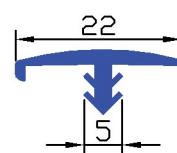

ref 220

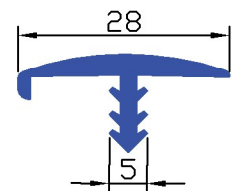

ref 246

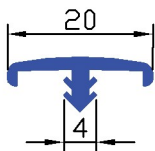

ref 527

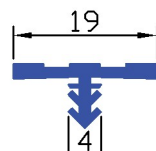

ref 212

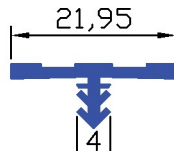

ref 214

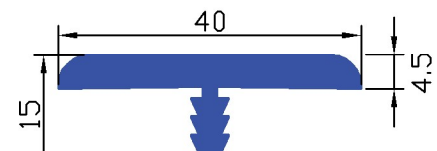

ref C19

**Descritivo** Perfil para rematar tampos e painéis, nos mais diferentes materiais.  
 Este perfil é de fácil e rápida colocação que confere um remate eficaz



**DUARTECRUZ**  
 SINCE 1956

Cores sob consulta

Fabrica de Plasticos, Lda Rua Visconde das devesas,305 4401-901 V.N.Gaia